

UCS

STRENGTH & SPEED
DIVISION

Jon Beason
Carolina Panthers
Linebacker

GLUTE-HAM MACHINE A-630613, pg 7

www.UCSSTRENGTH.com

Call toll-free 1-800-526-4856

511 Hoffman Road, Lincolnton, NC 28092

UCS

STRENGTH & SPEED

DIVISION



Washington State University
X-20 Rack Systems and Multi-Function
Benches with Docking Stations

Dedicated to research, development, and engineering, UCS uses a highly skilled work force to manufacture athletic equipment known for its quality, revolutionary design, and unparalleled safety. As a premier track and field company, UCS has been the sole supplier to four Olympic Games, Olympic Trials, NCAA Championships, and numerous championships worldwide.

UCS is proud to produce the Strength & Speed Division. This advanced line consists of racks, benches, platforms, glute-hams, leg presses, towers, and the renowned Plyo-Safe™ equipment. Cutting edge engineering, precision tooling, and powder-coating in-house allows for customization unmatched in the industry.

We look forward to working with you on upcoming facility projects. The drive and dedication of your athletes and our customers compels us to strive for the highest quality products in the world.

Warning! Failure to comply with these instructions could result in serious injury or death.

Read and observe all warnings and instructions posted on equipment and contained in instruction manuals. Inspect the equipment carefully before use. Do not use equipment if you observe any worn, missing, or damaged components. • Consult a physician prior to commencing an exercise program. If at any time during exercise you feel faint, dizzy, or experience pain, stop and consult your physician. • Consult a trained supervisor to familiarize yourself with the equipment's performance characteristics and proper use. • Never use any means of adding resistance to the equipment other than those approved by UCS. • Be sure that pins/accessories are completely inserted. • Be sure that you know how to properly adjust and engage all moving/locking parts prior to use. • Keep body, hair, clothing, and jewelry free and clear of all moving parts. • Keep children away from the equipment. • Ensure all warning labels are in place and legible. To replace any missing or worn labels contact UCS.

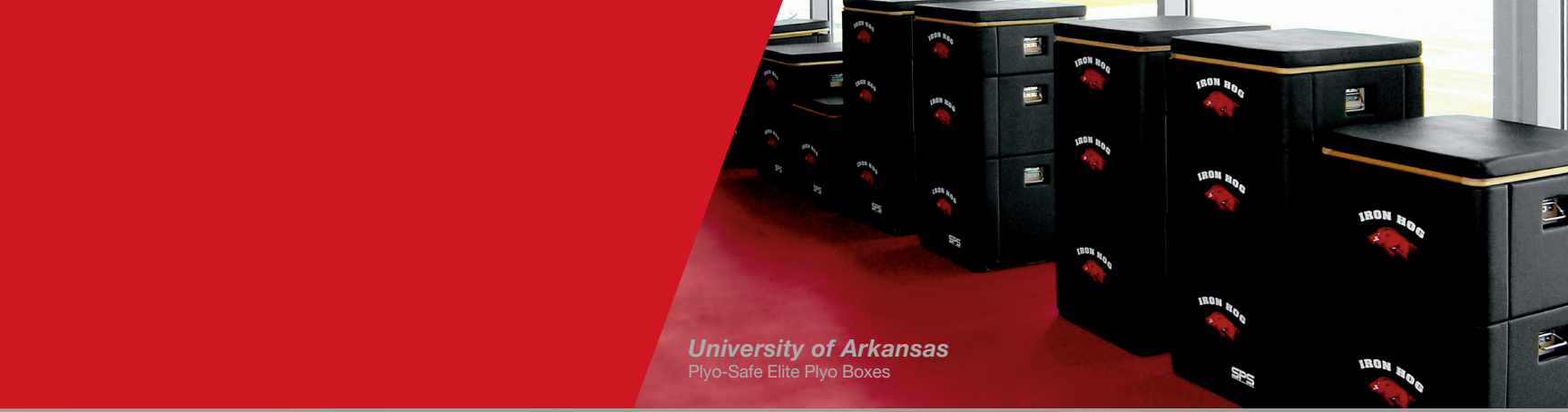

University of Arkansas
Plyo-Safe Elite Plyo Boxes

THE UCS LEASING PROGRAM

An easier way to afford the best.



Institutional leasing is quick and simple! Call 1-800-526-4856 to discuss your equipment needs and customized leasing program.

- Customized leasing programs with up to seven years repayment
- 10-year guarantee on material and workmanship

CONTENTS

Dumbbell Area	22
Facility Padding	29
Glute-Ham Machine	7
Medicine Ball Bench	24
Multi-Function Bench	23
Olympic Benches	25
Platforms	21
Plyo-Safe™ Equipment	28
Towers	26
X-Rack Systems & Accessories	8

Strength & Speed equipment is manufactured in-house at the Lincolnton, North Carolina facility.



 Contract #GS0-03F-0092V
Advantage![®]

 @UCSSPIRIT  /UCSSPIRIT

MEET OUR STAFF

Would you like to meet with a UCS sales executive?
Call 1-800-526-4856 and we will arrange a visit at
your convenience.

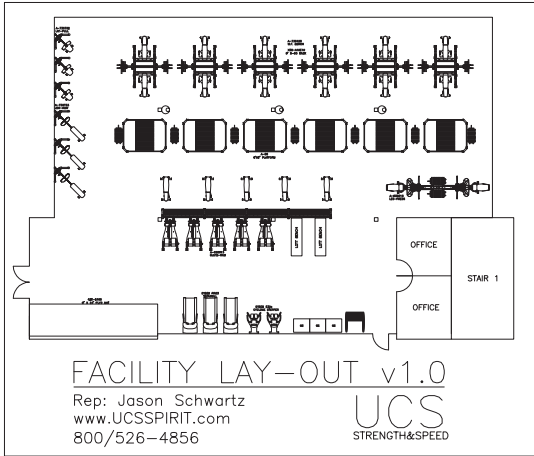

FACILITY LAYOUT ASSISTANCE

The Strength and Speed staff works closely with coaches, architects, and consultants throughout the world on major facilities. We can assist with the layout of your facility and ensure the equipment best utilizes the space. Specifications and detailed drawings are available for any of our products. Please email info@ucsspirit.com or call us at 1-800-526-4856 for more information.



X20-A19S

Steve Smith
WR - Carolina Panthers

FACILITIES USING STRENGTH & SPEED EQUIPMENT INCLUDE:



PROFESSIONAL TEAMS

Arizona Cardinals
Atlanta Falcons
Baltimore Ravens
Buffalo Bills
Cleveland Browns
Denver Broncos
Green Bay Packers
Indianapolis Colts
Jacksonville Jaguars
Minnesota Vikings
New England Patriots
New Orleans Saints
New York Giants
New York Jets
San Diego Chargers
Seattle Seahawks
Tampa Bay Buccaneers

Cleveland Cavaliers
Indiana Pacers
Los Angeles Lakers
New Orleans Hornets
Utah Jazz

Buffalo Sabers
Florida Panthers
Los Angeles Kings
New Jersey Devils
Pittsburgh Penguins
Tampa Bay Lightning

Cleveland Indians
Detroit Tigers
Pittsburgh Pirates
San Diego Padres
Washington Nationals

Colorado Rapids
NY/NJ Red Bulls
Seattle Sounders

PERFORMANCE CENTERS

Davis Training Systems
Go Performance
Parisi Speed Schools
Peak Performance

COLLEGES/UNIVERSITIES

University of Arkansas
Boston College
Boston University
Charleston Southern University
Clemson University
University of Colorado
Columbia University
Florida State University
University of Iowa Football
John Hopkins University
Kansas State University
University of Kentucky
Louisiana State University
University of Louisville
University of Michigan
University of Mississippi
Muhlenburg College
North Carolina State
University of North Carolina
Oregon State University
University of Pittsburgh
Rice University
Rutgers University
University of Illinois - Champaign
Southern Illinois University
University of South Carolina
University of Vermont
Vanderbilt University
Wake Forest University
Washington State University
West Virginia University
Wofford University

HIGH SCHOOLS

Cresskill High School
De La Salle High School
Don Bosco Academy
Fitzgerald High School
Georgetown Prep Academy
Isidore Newman School
Naples High School
Richmond County High School
University High School
Vista Grande High School

GOVERNMENT AGENCIES

United States Air Force
United States Army
United States Marine Corps
United States Navy

Wofford University
X-20 Rack Systems









Check out installation photos at www.UCSSTRENGTH.com

www.UCSSTRENGTH.com toll-free 1-800-526-4856

511 Hoffman Road, Lincolnton, NC 28092 p 704-732-9922 f 704-732-9559

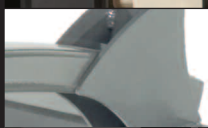
THE UCS DIFFERENCE

Strength and speed are important to your athletes and your program. UCS Strength and Speed equipment provides a foundation to build great athletes. Each piece of equipment is carefully designed to maximize workouts and durable enough to withstand the demands of an entire team. At UCS Strength and Speed we don't just build high quality equipment, we partner with our customers. Your feedback helps us design and manufacture strength training equipment for today's athletic programs. We deliver quality so you can deliver results.

	<p>EXCLUSIVE LINEAR BEARING SYSTEMS</p> <p>UCS exclusively uses block and rail linear bearings. The unique system eliminates all of the "flex" and bouncing of tube and collar systems.</p>
	<p>PADDING</p> <p>Striving to revolutionize all aspects of equipment, UCS has developed a unique stitch pattern that completely removes seams from high pressure areas. This provides a comfortable platform and a more durable pad.</p>
	<p>HYDRAULIC PISTON</p> <p>In an effort to enhance the efficiency of today's strength facility, UCS utilizes a hydraulic piston to enable quick and safe adjustments from a seated position.</p>
	<p>POWDER-COATING</p> <p>UCS is renowned for its powder-coating quality. Our in-house system ensures the highest paint adhesion. Sandblasting removes all impurities from within the steel, keeping equipment looking new for years.</p>
	<p>HOOK PLATE</p> <p>In order to maintain the integrity of our 7-gauge steel systems, UCS racks feature our nickel-plated hook plate. Laser cut from 3/4" steel, the smooth edges eliminate common pinch points. The nickel plating is guaranteed not to chip or rust.</p>
	<p>7-GAUGE STEEL</p> <p>Fully welded 7-gauge steel tubing and laser cut 1/4" to 3/4" plates are exclusively used on all Strength and Speed products.</p>
	<p>HDPE PLASTIC</p> <p>In order to protect the equipment and training bars from metal to metal contact, UCS features highly resilient shatter proof HDPE coatings on all potential contact point.</p>
	<p>SIDE ENTRY WEIGHT STORAGE</p> <p>All UCS racks are available with an optional side entry weight storage, allowing the rack to be flush against the wall with side entry for spotters.</p>
	<p>LOCKING ACCESSORIES</p> <p>The locking mechanisms used in our equipment are specially designed for our number one goal: safety. Bar holders, safety spot arms, and many other pieces utilize this feature allowing for quick repositioning.</p>

STANDARD FRAME COLORS

Custom colors available, contact factory for details.



STANDARD VINYL COLORS

Custom colors available, contact factory for details. Colors provided by Boltflex color chart.



GLUTE-HAM MACHINE

Innovative engineering, stylish design, and durability are combined to create the most impressive Glute-Ham Machine. Its unique design allows athletes of all sizes to perform activities safely and comfortably.

- 72" L x 38" W
- 7-gauge steel construction, fully welded frame
- An innovative pad design offers numerous activity positions in addition to traditional glute-ham exercises
- Curved upper pads offer a unique shelf to help align the athlete into proper position (photo C)
- A gradual curve of the pads creates a comfortable, supportive platform
- Pad can rotate to a flat padded platform, ideal for abdominal activity
- Two welded band attachments increase the Glute-Ham's versatility
- The foot support system operates on hidden rails beneath the platform, providing a walk-through design eliminating the tripping hazard of a center support bar (photo A)
- The piston-driven footrest raises the pads vertically by depressing one foot pedal or horizontally by depressing the other foot pedal (photo B)



A-630613

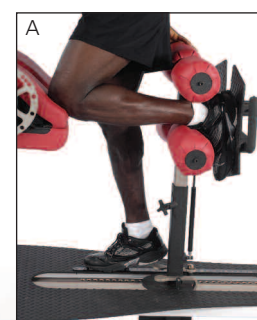

Glute-Ham		
Code #	Description	Price
A-630613	Glute-Ham Machine	\$3,600

Custom colors available

Clemson University

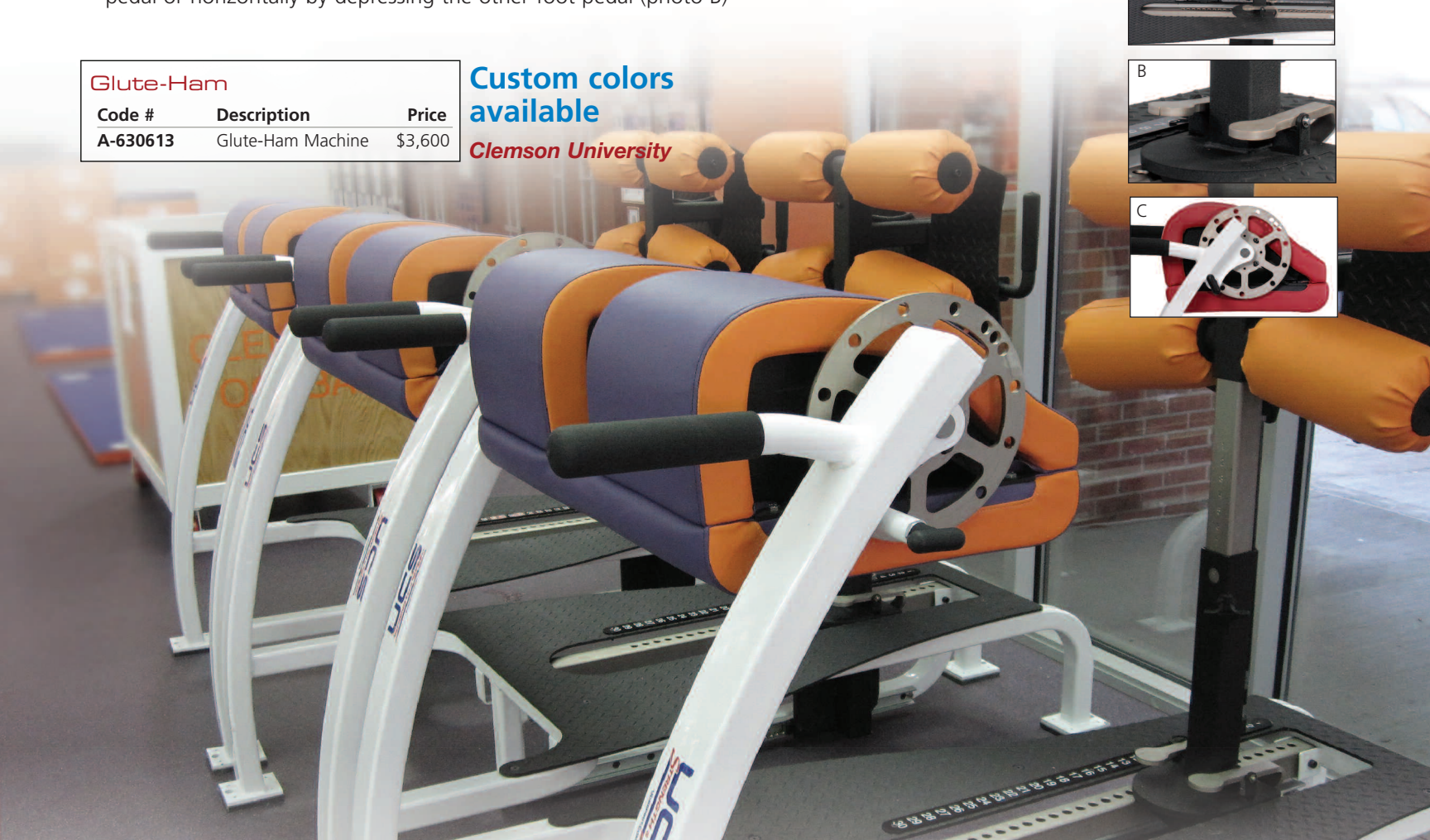

X-10 RACK SYSTEM

The X-10 Series Rack System is built to provide the versatility of the X-20 in a more compact footprint. Designed to accept both Olympic and bumper plates, the low-profile plate storage opens up sight lines in a facility.

- 7-gauge tubing, welded, upright and base construction
- Frame, base, and accessories are sandblasted prior to powder-coating, creating the highest possible powder to steel adhesion properties
- Standard Equipment: Low-profile bumper plate storage unit, vertical bar sleeves, quick-release single bar holders, safety spot arms, a 15" deep spotters area manufactured out of 1/4" steel diamond plate and powder-coated Wrinkle Black. Optional: Pull-Up Bar
- Available in 8' or 9' heights

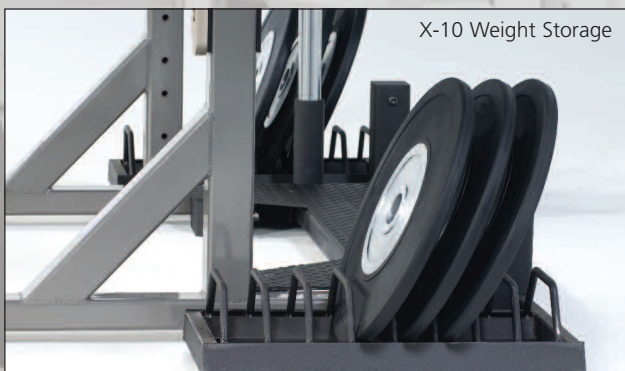

X-10 Weight Storage

X-10 Rack System		
Code #	Description	Price
X10-A185	8' Rack w/ Horizontal Weight Storage	\$2,350
X10-A195	9' Rack w/ Horizontal Weight Storage	\$2,350
Accessories: X-10 Rack		
Code #	Description	Price
B-538910	Technique Scoops (pair)	\$645
B-538904	Combo Grip Pull-Up Bar	\$245
B-538909	Combo Grip Fat Pull-Up Bar	\$295
Olympic Platforms with Logos and Inserts		
Code #	Description	Price
P-861	8' x 6' Platform w/ Logo & Insert	\$2,250
P-881	8' x 8' Platform w/ Logo & Insert	\$2,350
B-538950	Bench Ramp (for use w/ platform)	\$180

Warning! When adding a pull-up bar to the X-10 Rack, UCS recommends securing the rack to either the facility floor or platform.



Wake Forest University

X10-A19S without platform





X10-A19S shown with accessories:
P-881 8' x 6' Platform
A-730420 Multi-Function Bench
B-538490 Bench Docking Station

**MORE
COMPACT
FOOTPRINT**

www.UCSSTRENGTH.com toll-free 1-800-526-4856

511 Hoffman Road, Lincolnton, NC 28092 p 704-732-9922 f 704-732-9559

X-20 RACK SYSTEM

Simplicity and versatility are key components of the X-20 Rack System. The X-20 is manufactured to the industry's highest standards. The open design lends itself to being the most functional and versatile rack for any weight room.

- 7-gauge tubing, welded, upright and base construction
- Frame, base, and accessory parts are pre-treated prior to powder-coating, creating the highest possible powder to steel adhesion properties
- Standard Equipment: Weight storage unit, bar holder, combo grip pull up bar, quick release single bar holders safety spot arms, and an 18" deep spotter's area manufactured out of diamond plate steel and powder-coated Wrinkle Black
- Available in 8' or 9' heights

X-20 Rack System

Code #	Description	Price
X20-A18S	8' Rack w/ Standard Weight Storage	\$2,795
X20-A18E	8' Rack w/ Side Weight Storage	\$3,100
X20-A19S	9' Rack w/ Standard Weight Storage	\$2,795
X20-A19E	9' Rack w/ Side Weight Storage	\$3,100

Accessories: X-30 Rack

Code #	Description	Price
B-538906	Pull-Up Bar w/ Rotating Handles	\$450
B-538909	Combo Grip Fat Pull-Up Bar	\$295
B-538910R	Reverse Technique Scoops (pair)	\$695
B-538911	Small Rack Band Attachment	\$445
B-538928	Dip Attachment	\$445

Olympic Platforms with Logos and Inserts

Code #	Description	Price
P-861	8' x 6' Platform w/ Logo & Insert	\$2,250
P-881	8' x 8' Platform w/ Logo & Insert	\$2,350
B-538950	Bench Ramp (for use w/ platform)	\$180



Aurora University

X20-A19S shown with accessories:
 P-881 8' x 8' Platform
 A-730420 Multi-Function Bench
 B-538490 Bench Docking Station
 B-538950 Bench Ramp
 B-538904 Combo Grip Pull-Up Bar

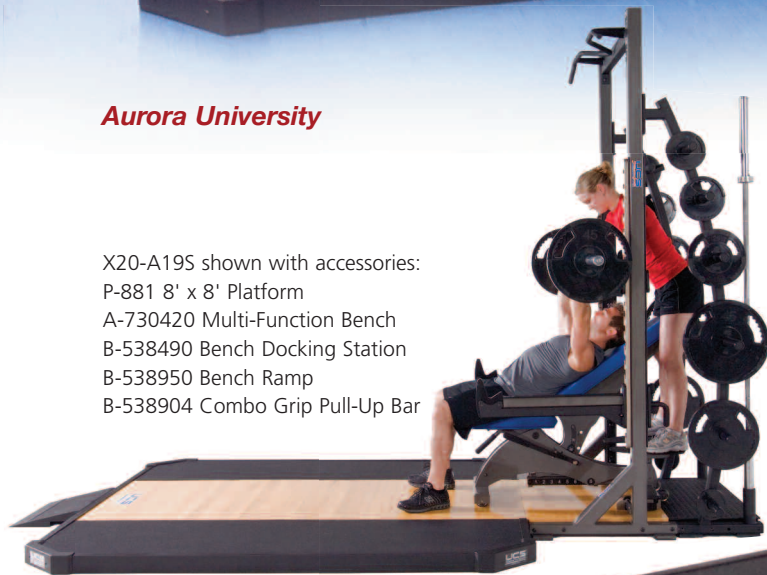

X20-A19E with Side Entry Weight Storage is designed to be flush against a wall.

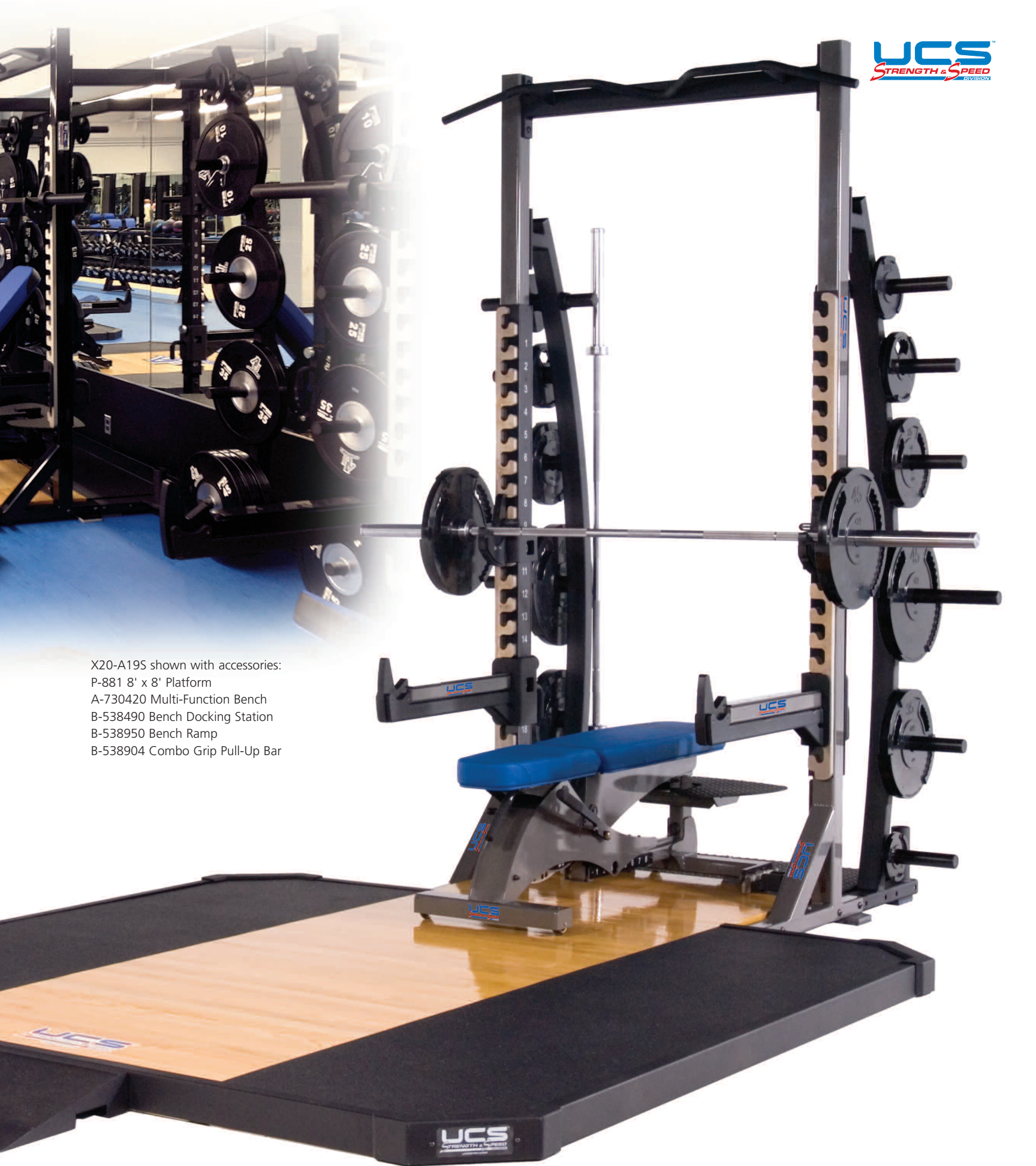

X20-A19S shown with accessories:
P-881 8' x 8' Platform
A-730420 Multi-Function Bench
B-538490 Bench Docking Station
B-538950 Bench Ramp
B-538904 Combo Grip Pull-Up Bar

X-30 RACK SYSTEM

The X-30 Series Rack System is one of the most versatile pieces of equipment in any strength program. Offering a safe and controlled environment, the X-30 Rack is perfect for facilities with limited space. The open design is ideal for a wide variety of exercises.

- Fully welded 3" x 3" 7-gauge steel tube side frames, powder-coated
- Standard Equipment: Weight storage unit, combo grip pull up bar, quick release single bar holders, interior safety spot arms, and an 18" deep spotter's area manufactured out of diamond plate steel and powder-coated Wrinkle Black
- Available in 8' or 9' heights

X30-A29S shown with accessories:
A-730420 Multi-Function Bench
B-538490 Bench Docking Station
B-538904 Combo Grip Pull-Up Bar



X-30 Rack System

Code #	Description	Price
X30-A28S	8' Rack w/ Standard Weight Storage	\$4,135
X30-A28E	8' Rack w/ Side Weight Storage	\$4,475
X30-A29S	9' Rack w/ Standard Weight Storage	\$4,135
X30-A29E	9' Rack w/ Side Weight Storage	\$4,475

Accessories: X-30 Rack

Code #	Description	Price
B-538906	Pull-Up Bar w/ Rotating Handles	\$450
B-538909	Combo Grip Fat Pull-Up Bar	\$295
B-538910R	Reverse Technique Scoops (pair)	\$695
B-538912	Large Rack Band Attachment	\$495
B-538928	Dip Attachment	\$445

Olympic Platforms with Logos and Inserts

Code #	Description	Price
P-862	8' x 6' Platform w/ Logo & Insert	\$2,350
P-882	8' x 8' Platform w/ Logo & Insert	\$2,450
B-538950	Bench Ramp (for use w/ platform)	\$180
P-2	Insert Only w/ Metal Frame	\$1,150



X-40 RACK SYSTEM

The powerful X-40 Series Rack System has the ability to adapt to any activity and is a valuable addition in any facility. The enclosed design makes it the safest rack for athletes.

- Four 3" x 3" 7-gauge welded uprights, powder-coated and equipped with an interior 3/4" steel nickel-plated hook plate
- Standard Equipment: Weight storage unit, bar holder, combo grip, pull-up bar, quick release single-bar holders, interior safety spot arms, and an 18" deep spotter's area manufactured out of diamond plate steel and powder-coated Wrinkle Black
- Available in 8' or 9' heights

X40-A39E with Side Weight Storage



X40-A39S shown with accessories:
A-730420 Multi-Function Bench
B-538490 Bench Docking Station
B-538904 Combo Grip Pull-Up Bar



X-40 Rack System

Code #	Description	Price
X40-A38S	8' Rack w/ Standard Weight Storage	\$4,250
X40-A38E	8' Rack w/ Side Weight Storage	\$4,580
X40-A39S	9' Rack w/ Standard Weight Storage	\$4,250
X40-A39E	9' Rack w/ Side Weight Storage	\$4,580

Accessories: X-30 Rack

Code #	Description	Price
B-538906	Pull-Up Bar w/ Rotating Handles	\$450
B-538909	Combo Grip Fat Pull-Up Bar	\$295
B-538910	Technique Scoops (pair)	\$645
B-538912	Large Rack Band Attachment	\$495
B-538928	Dip Attachment	\$445

Olympic Platforms with Logos and Inserts

Code #	Description	Price
P-863	8' x 6' Platform w/ Logo & Insert	\$2,350
P-883	8' x 8' Platform w/ Logo & Insert	\$2,450
B-538950	Bench Ramp (for use w/ platform)	\$180
P-3	Insert Only w/ Metal Frame	\$1,150



Rutgers University

X-50 RACK SYSTEM

The versatile and efficient X-50 Rack System allows two athletes to engage in activity at the same time, each with an individual spotter. With the ability to adapt to any program and create more space, the X-50 Rack System is the most popular rack at all levels.

- Four 3" x 3" 7-gauge welded uprights, linked together by a double sided side entry weight storage system (Wrinkle Black powder-coated), giving both sides the ability to store equal amounts of plates
- Standard Equipment: Dual sided side entry weight storage unit, safety spot arms, vertical bar storage, two combo grip pull-up bars, two pairs of quick-release single bar holders, 36" deep spotter's area manufactured out of diamond plate steel and powder-coated Wrinkle Black
- Available in 8' or 9' heights



University of Pittsburgh

X50-AM19E19 shown with accessories:

- P-881 Platform
- A-730420 Multi-Function Bench
- B-538490 Bench Docking Station
- B-538910 Technique Scoops
- B-538904 Combo Grip Pull-Up Bar
- B-538950 Bench Ramp
- B-538906 Pull-Up Bar with Rotating Handles



X-50 Rack System

Code #	Description	Price
X50-AM18E18	8' Rack System w/ Dual Side Entry Weight Storage	\$5,500
X50-AM19E19	9' Rack System w/ Dual Side Entry Weight Storage	\$5,500

Accessories: X-50 Rack

Code #	Description	Price
B-538906	Pull-Up Bar w/ Rotating Handles	\$450
B-538909	Combo Grip Fat Pull-Up Bar	\$295
B-538910	Technique Scoops (pair)	\$645
B-538911	Small Rack Band Attachment	\$445
B-538928	Dip Attachment	\$445

Olympic Platforms with Logos and Inserts

Code #	Description	Price
P-8611	8' x 6' Platform w/ Logo & Insert	\$4,500
P-8811	8' x 8' Platform w/ Logo & Insert	\$4,700
P-861	8' x 6' Single Sided Platform w/ Logo & Insert	\$2,250
P-881	8' x 8' Single Sided Platform w/ Logo & Insert	\$2,350
B-538950	Bench Ramp (for use w/ platform)	\$180





Stacy Dragila
2000 Olympic Gold Medal
Women's Pole Vault

X50-AM19E19 shown with accessories:
P-881 8' x 8' Platform
A-730420 Multi-Function Bench
B-538490 Bench Docking Station
B-538910 Technique Scoops
B-538950 Bench Ramp
B-538904 Combo Grip Pull-Up Bar
B-538906 Pull-Up Bar with Rotating Handles

X-60 RACK SYSTEM

With two workout areas, the X-60 Rack System offers the versatility of the X-20 with the safety, adaptability, and control of the X-40 system.

- Four 3" x 3" 7-gauge standard uprights, equipped with hook plates, plus an additional interior facing 3" x 3" welded upright
- Standard Equipment: Weight storage unit, one pair of internal safety spot arms, bar-holder, combo grip pull-up bar, two pairs of quick release single-bar holders, 18" deep spotter's area manufactured with diamond plate steel and powder-coated Wrinkle-Black
- Available in 9' height only



Arizona Cardinals
Also shown: Technique Boxes, page 21

X60-A49S shown with accessories:
A-730420 Multi-Function Bench
B-538490 Bench Docking Station
B-538904 Combo Grip Pull-Up Bar
B-538901 Safety Spot Arms



X-60 Rack System		
Code #	Description	Price
X60-A49S	9' Rack w/ Standard Weight Storage	\$4,885
X60-A49E	9' Rack w/ Side Weight Storage	\$5,140
Accessories: X-60 Rack		
Code #	Description	Price
B-538906	Pull-Up Bar w/ Rotating Handles	\$450
B-538909	Combo Grip Fat Pull-Up Bar	\$295
B-538910	Technique Scoops (pair)	\$645
B-538901	Safety Spot Arms (pair)	\$545
B-538911	Small Rack Band Attachment	\$445
B-538912	Large Rack Band Attachment	\$495
B-538928	Dip Attachment	\$445
Olympic Platforms with Logos and Inserts		
Code #	Description	Price
P-864	8' x 6' Platform w/ Logo & Insert	\$2,925
P-884	8' x 8' Platform w/ Logo & Insert	\$3,000
B-538950	Bench Ramp (for use w/ platform)	\$180





X60-A49S shown with accessories:
P-884 Platform
A-730420 Multi-Function Bench
B-538490 Bench Docking Station
B-538950 Bench Ramp
B-538901 Safety Spot Arms
B-538904 Combo Grip Pull-Up Bar

X-70 RACK SYSTEM

Offering the ultimate strength facility efficiency, the X-70 Rack System is the choice of many university and professional strength programs.

- Activity zones for three athletes
- Six 3" x 3" 7-gauge welded uprights, two 3" x 3" interior facing uprights, equipped with 3/4" steel, nickel-plated hook plates
- Unique dual side-entry weight storage system providing space for plates facing in both directions, making weight selection and replacement safe, easy, and non-disruptive to other users
- Additional weight storage (more than single side-entry) ensuring enough equipment for the three activity areas
- Standard Equipment: Double side-entry weight storage, one pair of interior safety spot arms, bar-holder, two combo-grip pull-up bars, three pairs of quick release single bar holders, three spotter's areas manufactured out of diamond plate steel and powder-coated Wrinkle-Black
- Available in 9' height only



X70-AM49E19 shown with accessories:
 P-884 8' x 8' Platform
 A-730420 Multi-Function Bench
 B-538490 Bench Docking Station
 B-538910 Technique Scoops
 B-538901 Safety Spot Arms
 B-538906 Pull-Up Bar with Rotating Handles
 B-538950 Bench Ramp
 B-538904 Combo-Grip Pull-Up Bar

X-70 Rack System

Code #	Description	Price
X70-AM49E19	9' Rack w/ Dual Side Entry Weight Storage	\$9,875

Accessories: X-70 Rack

Code #	Description	Price
B-538906	Pull-Up Bar w/ Rotating Handles	\$450
B-538909	Combo Grip Fat Pull-Up Bar	\$295
B-538910	Technique Scoops (pair)	\$645
B-538901	Safety Spot Arms (pair)	\$545
B-538911	Small Rack Band Attachment	\$445
B-538912	Large Rack Band Attachment	\$495
B-538928	Dip Attachment	\$445

Olympic Platforms with Logos and Inserts

Code #	Description	Price
P-8641	8' x 6' Platform w/ Logo & Insert	\$5,175
P-8841	8' x 8' Platform w/ Logo & Insert	\$5,295
B-538950	Bench Ramp (for use w/ platform)	\$180
P-861	8' x 6' Single Sided Platform w/ Logo & Insert	\$2,250
P-881	8' x 8' Single Sided Platform w/ Logo & Insert	\$2,350





X70-AM49E19 shown with accessories:
 P-884 8' x 8' Platform
 A-730420 Multi-Function Bench
 B-538490 Bench Docking Station
 B-538910 Technique Scoops
 B-538901 Safety Spot Arms
 B-538906 Pull-Up Bar with Rotating Handles
 B-538950 Bench Ramp
 B-538904 Combo-Grip Pull-Up Bar



ACCESSORIES

To enhance the functionality of your UCS equipment there are several options, upgrades, and complimentary products available. These accessories integrate seamlessly with racks, benches, and platforms. Manufactured from 7-gauge steel, all accessories are fully welded.



Horizontal Weight Storage

Stores both certified and fat bumper plates. Fully welded plate support rails. Tilt 'n roll option available.

A-HFR-5 Holds 5 Bumpers \$300

A-HFR-10 Holds 10 Bumpers \$500

A-HFR-5W Holds 5, w/ wheels \$375

A-HFR-10W Holds 10, w/ wheels \$575



Dip Attachment

Variable width positions for different sized athletes. Non-slip grip adds safety.

B-538928 \$445



Bar Holders

Quick Lock Single Bar Holders are standard on all UCS racks. Spring loaded lock for added safety. Composite HDPE hook protects the bar.

B-638903 \$25/pair



Safety Spot Arms

100% 7-gauge construction. HDPE hook at front prevents bar roll-off and offers additional starting point for activities. Padded handle for easy adjustment.

B-538901 \$545/pair



Multi-Position Rack Band Attachment

Allows elastic bands to be used during training.

B-538911 Small Band Attachment \$445/pair

B-538912 Large Band Attachment \$495/pair

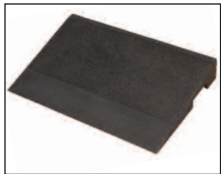

Platform Ramp

Allows bench to easily roll on and off UCS platforms. Steel frame with built-in handles and durable rubber surface.

538950 \$180



Technique Scoops

Fully welded 7-gauge construction.

B-538910 \$645/pair



Docking Station flips up and secures into place when not in use. Down position allows three locations to lock bench into rack frames (photo A). Bench's tilt 'n roll action disengages and engages the locking station (photos B & C).



Pull-Up Bars

Pull-up bar with rotating handles can be adjusted to meet training requirements.

B-538906 Bar with Rotating Handles \$450



Powder-coated steel tubing, knurled solid bars.

B-538903 Straight Bar 1 1/8" Thick \$245

B-538904 Combo Grip Bar 1 1/8" \$500

B-538909 Combo Grip Fat Bar 1 1/2" \$375

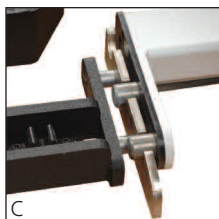
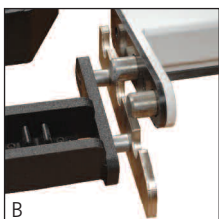
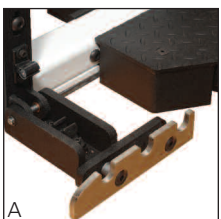

Docking Station

Standard with Multi-Function Bench orders. Centers and secures bench between rack uprights.

B-538490 \$299/pair

X-SERIES FREE-STANDING PLATFORMS

UCS Platforms are constructed from the finest materials available to provide the strongest, most durable platforms on the market. The unique "cropped corner" shape eliminates dangerous edges and tripping hazards. A custom formed 11-gauge steel frame with a 1½" steel lip and routed understructure corners ensure the frame cannot be dislodged during use. Comprised of four layers, the two rubber sections are first constructed with 2" x 4" select pine followed by a layer of 1⅛" proprietary wood elements. The final layer is ¾" rubber surface to absorb the impact of weights, minimizing noise. The center section is built identically to the rubber sections with the final layer ¾" select tongue and groove oak. Six layers of polyurethane protect the logos and platform. Two layers are applied prior to logo application.



Platforms w/ Logos & Insets

Code #	Description	Price
P-88	8' x 8' Olympic Platform w/ Logo	\$1,800
P-86	8' x 6' Olympic Platform w/ Logo	\$1,700

Custom logos available, contact factory for details.

TECHNIQUE BOXES

Our oak constructed Technique Boxes are manufactured from ¾" oak and sealed with polyurethane. The interior construction has been specially designed to allow for safe and easy stacking. To increase strength and durability, the understructure is ¾" oak, while powder-coated steel corner strips provide additional strength. The top layer of each box is ¾" rubber with two strips of Purple Heart Oak. The Purple Heart Oak helps prevent the plates and bar from accidentally rolling off. Technique Boxes are equipped with a pair of stainless steel handles to aid in moving the equipment.



Technique Boxes

Code #	Description	Price
A-540273	One Pair 12"	\$599
A-540272	One Pair 6"	\$349
A-540271	One Pair 3"	\$199
A-540270	Complete Set	\$1,100
A-540279	Custom Size	Call

Custom logos available, contact factory for details.

ADJUSTABLE INCLINE BENCH

- 54" L x 24" W
- One piece laser cut 1/4" steel plate and 7-gauge tube components create the stable bench understructure
- Adjustments can be performed while seated
- Pneumatic piston driven back pad support structure
- Back angle positions are 0, 20, 35, 45, 50, 60, 65, and 82 degrees (photo B)
- Front seat adjusts independently to five positions
- Specially designed 3" total height pad with 2" EVA foam
- The welded handle and non-marring wheels enable tilt 'n roll mobility (photo A)
- Unique stitch pattern removes seams from high pressure points



A-730123

Adjustable Incline Bench

Code #	Description	Price
A-730123	Adjustable Incline Bench	\$1,150
A-730421	Removable Head Wrap	Call



DUMBBELL RACK

- Constructed using 3" x 3" 7-gauge steel, these fully welded side frames are joined together by 1/4" steel plate shelves
- Rubber saddles (photo A) ensure dumbbells stay in place and prevent damage to shelves and dumbbells



A-530822



Wofford University

Dumbbell Rack

Code #	Description	Price
A-530821	Single Tier - 5 Pairs	\$950
A-530822	Double Tier - 10 Pairs	\$1,150
A-530823	Triple Tier - 15 Pairs	\$1,450

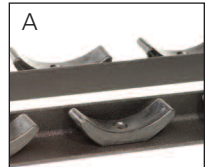

MULTI-FUNCTION BENCH WITH DOCKING STATION

The Multi-Function Bench is the perfect compliment to any X-Series Rack.

- 54" L x 24" W (fully extended)
- Laser cut 1/4" steel plate and 7-gauge tube components create the stable bench understructure
- One piece back support structure eliminates flexing of the frame during activity
- All adjustments can be performed while seated
- Horizontal movement is achieved with a block and rail bearing system allowing 12 1/4" total bench travel
- A pneumatic piston assists the adjustment of the bench back to these positions: 0, 20, 35, 45, 50, 60, 65, and 82 degrees (photo A)
- Front seat adjusts independently to five positions, from 0-35 degrees
- Specially designed 3" total height pad, with 2" EVA foam
- Unique stitch pattern removes seams from high pressure points
- Raised, diamond plate spotter's platform
- Welded handle and non-marring wheels enable tilt 'n roll mobility (photo B)
- Standard with Docking Station



Georgetown Preparatory School

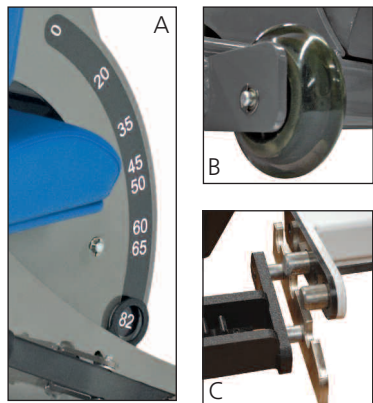

A-730420

Multi-Function Bench

Code #	Description	Price
A-730420	Multi-Function Bench	\$1,850
A-730421	Removable Head Wrap	Call

MEDICINE BALL BENCH

The adjustable Medicine Ball Bench's support platform allows the athlete to select from five different positions. The ankle pads adjust for support during activity. An oversized platform provides a position for the spotter to enhance exercises using a variety of tools such as weight balls.

- 85" L x 28" W
- 7-gauge steel construction
- Oversized spotter's platform
- 5-Position piston-assisted adjustable support pad (photo A)
- Fully-welded frame
- Adjustable ankle pads for a secure fit (photo B)

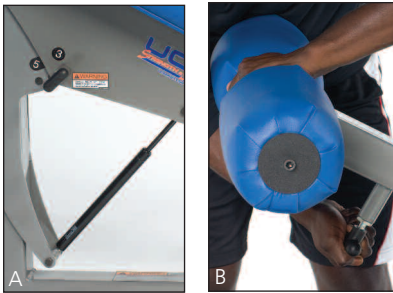

Medicine Ball Bench		
Code #	Description	Price
A-630350	Medicine Ball Bench	\$1,550

ADJUSTABLE PRONE ROW

UCS is proud to introduce the first Adjustable Prone Row Bench, which incorporates exclusive gas piston driven body support.

- 65" L x 48" W
- Gas spring assisted system adjusts prone row from 0° to 30° in 5° increments
- 3" x 3" 7-gauge steel tubing uprights protected by 1/4" high density polyethylene (HDPE)
- Leg roller support is adjustable 15" in length in 3" increments
- Bar height is adjustable up to 8" in 2" increments
- Specially designed 2" EVA pad conforms to the athlete's body providing excellent support
- Twist and Lock Bar Holders are made of 1/2" laser cut and formed steel with high density polyethylene (HDPE) guard and spring loaded pin lock for safety



Prone Row		
Code #	Description	Price
A-630301	Prone Row Bench	\$1,980

OLYMPIC SERIES BENCHES

Constructed with 3" x 3" 7-gauge steel, these fully welded benches are built to keep pace with any strength program. Made of HDPE composite plastic, the twist and lock bar holders allow for quick adjustments. Olympic Benches include a spotter's platform.

- 3" x 3" 7-gauge steel tubing uprights protected by 1/4" high density polyethylene (HDPE)
- Bar Holders are made of 1/2" laser cut steel with HDPE guard and spring loaded pin lock
- 12-peg weight storage
- Spotter's platform is 1/4" thick diamond plate Wrinkle Black powder-coated
- 2" x 3" 7-gauge steel tubing and 1/4" steel laser cut plate on front frame
- Seat pad is made with 2" thick EVA foam



A-630412

OLYMPIC FLAT BENCH



A-630412

- 74" L X 67" W
- Bar height is adjustable up to 10 inches

Olympic Flat Bench

Code #	Description	Price
A-630412	Olympic Flat Bench w/ Storage	\$1,700
A-630413	Olympic Flat Bench w/o Storage	\$1,500



A-630417

OLYMPIC MILITARY PRESS

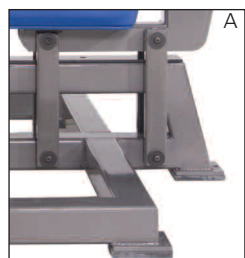

A

- 54" L x 67" W
- Seat is adjustable horizontally up to 8" in 1" increments (photo A)
- Bar height is adjustable up to 10" in 2" increments

Olympic Military Press Bench

Code #	Description	Price
A-630417	Military Press Bench w/ Storage	\$1,950
A-630418	Military Press Bench w/o Storage	\$1,750

OLYMPIC INCLINE BENCH



B

- 67" L x 67" W
- Seat height is adjustable up to 7 1/2" in 1/2" increments (photo B)
- Bar height is adjustable up to 10" in 2" increments
- Unit can be ordered to be built at 30°; 31°; 32°; 33°; 34°; 35°; 36° (standard), 37°, and 38°

Olympic Incline Bench

Code #	Description	Price
A-630414	Olympic Incline Bench w/ Storage	\$1,900
A-630415	Olympic Incline Bench w/o Storage	\$1,700



University of Illinois
A-630414

TOWERS

Standing 9'6" in height, UCS Towers have been engineered to accommodate any size athlete. Constructed of 7-gauge tubular steel and laser cut steel plate, the towers continue the tradition of fully welded equipment. The 250 lb weight stacks utilize a ball bearing collar for smooth and quiet movement. With three adjustable rubber feet (photo A), the tower will always sit flush on the surface. For added safety and unique space saving designs, the towers can be attached to form a two-piece, three-piece or four-piece tower system.

LOW ROW

Adjustable pulley system allows the athlete to raise or lower the pull point to accommodate their unique body type (photos B,C). The pad is long 38½" long.

- 94" L x 48" W
- 1/8" steel front and back curved shields conceal the weight stacks
- Three rubber mounted leveling feet to provide correct vertical alignment and stability on any floor (photo A)
- 250 lbs Weight Stack

Low Row		
Code #	Description	Price
A-703	Low Row Tower	\$3,600

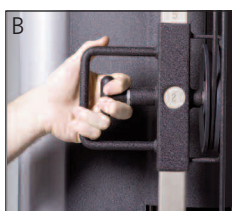

North Carolina State University



A-703

Steve Smith
WR - Carolina Panthers

LAT PULL-DOWN

The Lat Pull-Down has an adjustable seat height as well as an adjustable pulley system to raise or lower the starting pull point.

- 54" L x 48" W
- 1/8" steel front and back curved shields conceal the weight stacks
- Three rubber leveling feet to provide correct vertical alignment and stability on any floor
- Pneumatic piston assisted seat height is adjustable using foot operated pedal (photo A)
- Bar height is adjustable up to 60" in 2" increments (photo B)
- 250 lbs Weight Stack

Lat Pull-Down		
Code #	Description	Price
A-702	Lat Pull-Down Tower	\$3,600

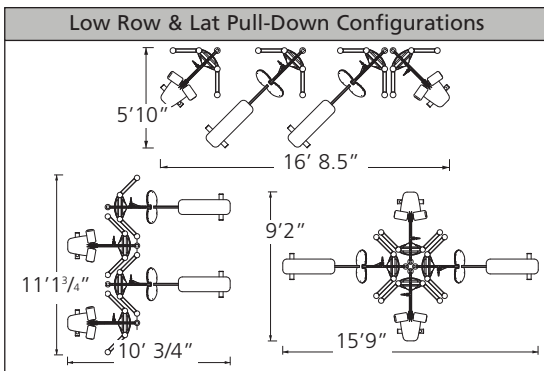



Creative imagination, state-of-the-art manufacturing, and requests from strength coaches and athletes have led to the creation of Plyo-Safe Systems. Plyo-Safe has built a reputation as the most innovative equipment designer in the industry. Backed by UCS, Plyo-Safe pulls from over 40 years of manufacturing experience in the athletic equipment industry. Plyo-Safe products offer unique platforms for training today's athletes. These systems provide an optimal combination of durability and safety while developing speed, explosive power, and flexibility.



Wake Forest University

PLYO MATS

With the ability to turn any space into a productive activity zone, the Plyo-Mat has a seamless top. The 2" high density polyethylene foam is encased in durable 21oz knife coated vinyl with leather grain finish. Without cracks there is no risk of injury from tripping or getting caught. The Plyo-Mat has a unique design (photo A) which allows quick folding.

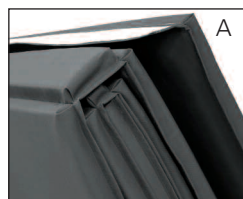

Plyo-Safe Mats		
Code #	Description	Price
425-1200	6' x 12' x 2"	\$720
425-1800	6' x 18' x 2"	\$1,080
425-2400	6' x 24' x 2"	\$1,450
425-8000	8' x 18' x 2"	\$1,450
425-9900	Custom Sizes	Call

DELUXE FOLDING MATS

140 Deluxe Folding Mats are encased in durable 21oz knife coated vinyl with leather grain finish. The 1' panel 2' fold design is lightweight and easy to store. The fold pattern ensures the mat will always lay flat when open. All seams and hems are double-folded and double-stitched with high tenacity nylon thread.

Deluxe Folding Mats		
Code #	Description	Price
140-44NV	4' x 4' x 1 ³ / ₈ "	\$135
140-46NV	4' x 6' x 1 ³ / ₈ "	\$175
140-48NV	4' x 8' x 1 ³ / ₈ "	\$235
140-50NV	5' x 10' x 1 ³ / ₈ "	\$325
140-62NV	6' x 12' x 1 ³ / ₈ "	\$435



PLYO-SAFE HURDLE

A safe and effective piece of equipment for use with most hurdle drills, the Plyo-Safe Hurdle is stable enough to stand but can be easily carried. Constructed from durable 21oz coated vinyl, the Plyo-Safe Hurdle can be used both inside and outside. The attachable foam boards allow four different heights: 30", 33", 36", and 39". Custom logos and colors are available. Footprint: 41" wide x 12" long.

Plyo-Safe Foam Hurdle		
Code #	Description	Price
A-10440	Plyo-Safe Hurdle	\$120



Foam boards attach using Velcro.

STANDARD VINYL COLORS

Custom colors available, contact factory for details.



FACILITY PADDING

An essential safety addition to any activity area, Pads and Wall Panels help protect the athlete from injury, improve the appearance of your gym, and absorb noise. Padding can be customized with your school name, logo, and colors. For a complete list of sizes and customizations available, call our factory at 1-800-526-4856.

WALL PROTECTION PANELS

Manufactured out of 3/8" wood backing with 2" thick 100 ILD foam, panels are covered in a double coated 14oz vinyl. Custom sizes are available with cutouts for light switches, outlets, and vents. Fire Retardant Wall Panels meet ASTM 84 regulations and are manufactured out of 2" FR-SAF foam, OSD 3/8" wood and 14oz. vinyl laminated material.



Cutouts and custom logo application available.

Wall Panels		
Code #	Description	Price
260-16	1' x 6'	\$65
260-18	1' x 8'	\$83
260-26	2' x 6'	\$105
260-28	2' x 8'	\$130
260-46	4' x 6'	\$175
260-48	4' x 8'	\$215

Robins Air Force Base

I-BEAM PADS

Manufactured from 1 3/8" crosslink polyethylene and 21oz. vinyl coated nylon, I-Beam Pads provide a thick cushion of protection to the flat surface of exposed beams. Velcro strips position the pad for optimal protection. Customization is available with your measurements (see diagrams on the right).

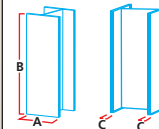

Custom sizes available.

I-Beam Pads		
Code #	Description	Price
260-01	6" x 6'	\$140

FAT PADS

Available in folding and non-folding models, Fat Pads are manufactured out of 21oz. vinyl knife coated nylon. The breather material offers the right amount of depression with an extra high resilient polyethylene allowing for years of vigorous use. Each pad comes with eight handles.



221-10



Mount at end of sprint track for safety. Custom logo application available.

Fat Pads		
Code #	Description	Price
221-05	4' x 8' x 8"	\$493
221-08	5' x 10' x 8"	\$663
221-10	5' x 10' x 12"	\$867
221-12	6' x 12' x 8"	\$884
221-13	6' x 12' x 12"	\$1,163

University of South Carolina

AGILITY HURDLE

The Agility Hurdle endures years of rigorous use and is powder-coated to avoid rust and discoloration. The fully welded 2" x 2" Zeneel tubular base is one solid unit. 1 1/2" Zeneel upright tubes are double welded to the base to prevent twisting. A welded weight in the base prevents tipping during activity. Telescoping aluminum tubes raise and lower the tri-ribbed Polycarbonate crossbar to five different heights (30", 33", 36", 39", and 42"). Footprint: 41" wide x 27.5" long.

Agility Hurdle		
Code #	Description	Price
A-3011	UCS Agility Hurdle	\$180



TELESCOPING TUBE & SCREEN COLORS

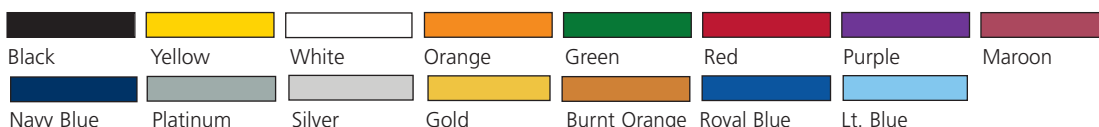

BASE COLORS

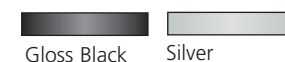

plyosafe **G2**
BOXES

Strength and Speed's Plyo-Safe line continues to revolutionize the plyometric industry. As with Plyo-Safe Elite Boxes, Plyo-Safe G2 Boxes offer the ultimate combination of durability, stability, and safety. With an extra large landing surface of 30" x 36", fears of missing the box are eliminated. They are made with a 100% polyurethane foam core that will not break down or delaminate, and a 21oz knife coated vinyl with built-in bacterial inhibitor. Handles on the 12", 18", and 24" allow for quick repositioning. Each box has three 2" strips of Velcro to enable stacking and prevent the boxes from slipping. Custom logos are available on 24" boxes, contact factory for details.



Plyo-Safe G2 Plyo-Boxes

Code #	Description	Price
A-540280	Set of G2 Plyo-Boxes (3", 6", 12", 18", 24")	\$1,795
A-540281	Set of 3 G2 Plyo-Boxes (12", 18", 24")	\$1,495
A-540282	30" x 36" x 3" Plyo-Box	Call
A-540283	30" x 36" x 6" Plyo-Box	Call
A-540284	30" x 36" x 12" Plyo-Box	Call
A-540285	30" x 36" x 18" Plyo-Box	Call
A-540286	30" x 36" x 24" Plyo-Box	Call
A-540289	Custom logo - 24" G2 Box	\$150



STANDARD VINYL COLORS

Custom colors available, contact factory for details.

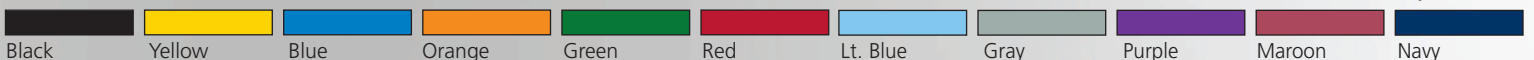

Custom logos available, contact factory for details.

plyo safe **ELITE BOXES**

A UCS original, these fully padded Plyo-Box sets (26" x 26" x specified height: measuring 24", 18", and 12") not only provide protection from common Plyo-Box injuries but give any weight facility a professional look. The understructure of this equipment is comprised of the finest 3/4" oak covered in a dense foam which is upholstered in tough 38oz Boltaflex vinyl. Each corner is strengthened with two stainless steel "L" brackets. A raised lip on all boxes allows stacking and locking of the lids. The 24" box is bottomed with 3/4" high density rubber for stability. With four primary pads and four curved corner pads there are no sharp edges or dangerous corners exposed to the athlete. Stainless steel handles are recessed on two sides of each box. Each pad is individually replaceable.

Plyo-Safe Plyo-Boxes are used by many facilities including:

- University of Arkansas
- Baltimore Ravens
- Boston University
- Buffalo Bills
- Buffalo Sabers
- Charleston Southern University
- University of Colorado
- De La Salle High School
- Green Bay Packers
- Indiana Pacers
- Los Angeles Lakers
- Los Angeles Kings

- Louisiana State University
- Muhlenberg College
- New England Patriots
- New Orleans Saints
- New York Giants
- New York Jets
- Pittsburgh Penguins
- University of Pittsburgh
- San Diego Padres
- Seattle Seahawks
- Southern Illinois University
- University of Vermont
- Washington State University
- West Virginia University
- and many more!

LaDarian Tomlinson



Rutgers University

University of Iowa

University of Louisville

Contrasting colors on center and corner pads available (lid matches center pads).

STANDARD VINYL COLORS

Custom colors available, contact factory for details.

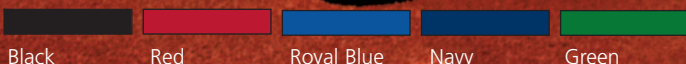

Plyo-Safe Elite Plyo Boxes		
Code #	Description	Price
A-540260	Set of 3 Plyo-Boxes: consists one each of the following:	\$2,595*
A-540261	26" x 26" x 24" Plyo-Box	Call
A-540262	26" x 26" x 18" Plyo-Box	Call
A-540263	26" x 26" x 12" Plyo-Box	Call
A-540269	Logo - per color	\$150

*Includes one lid per box.

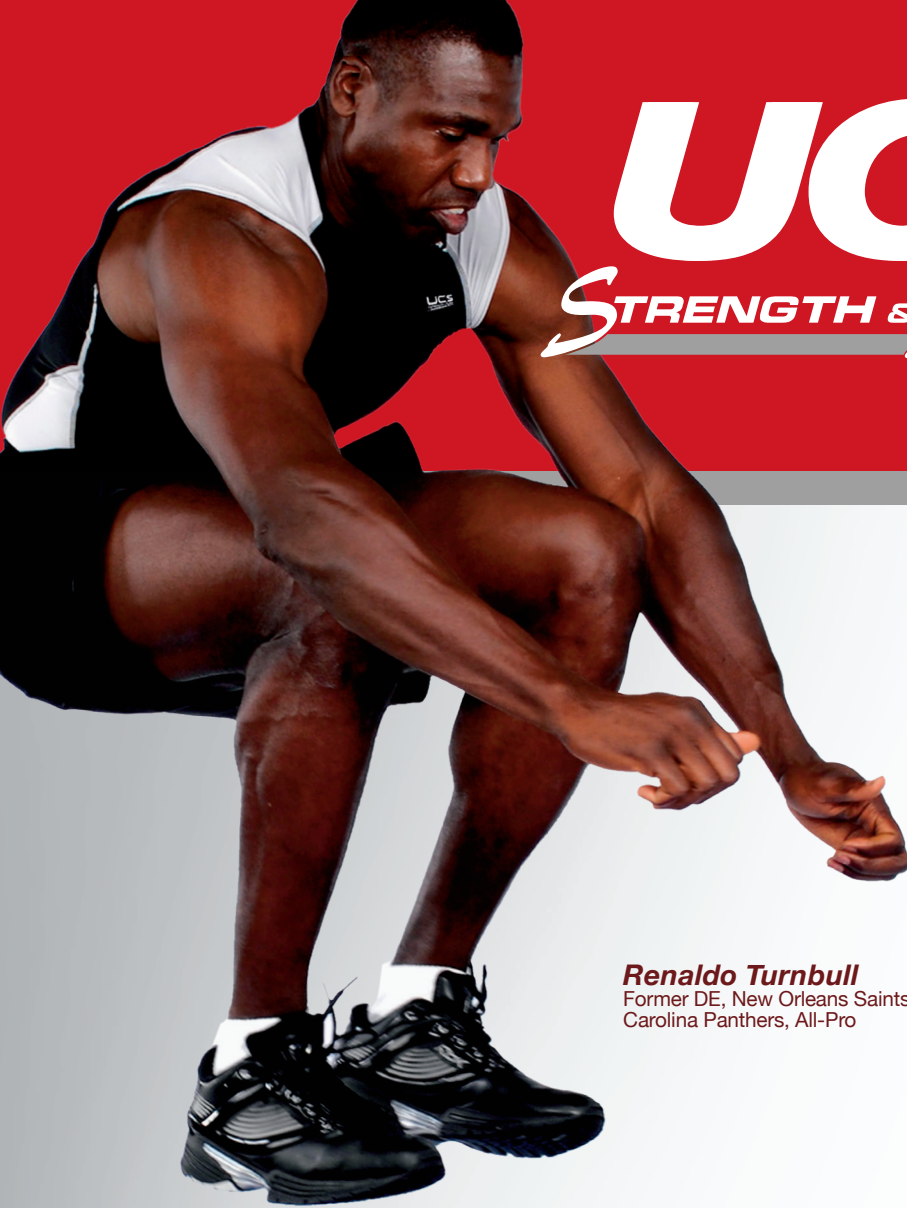

UCS

STRENGTH & SPEED
DIVISION



plyo safe

ELITE PLYO-BOXES

A-540260, page 30

Plyo-Safe Plyo-Boxes are fully padded safe-landing surfaces that are stackable for various heights. Customize with colors and logos to extend the professional look your facility deserves! 10-year warranty.

Renaldo Turnbull
Former DE, New Orleans Saints
Carolina Panthers, All-Pro



www.UCSSTRENGTH.com

Call today! 704-732-9922

toll-free 800-526-4856 fax 704-732-9559

511 Hoffman Road, Lincolnton, NC 28092